

# Operation Manual

## Ice Cream Spaghetti - Press

### **180P**





## Table of Contents:

### Contents

1	Preface .....	4
1.1	Introduction .....	4
2	Safety Instructions .....	5
2.1	Symbols and Notes .....	5
2.2	Basic Security Instructions .....	6
2.3	Intended Use .....	6
3	Device Description.....	7
3.1	General Terms .....	7
3.2	Technical Specifications * .....	7
4	Assembly Instructions .....	8
4.1	Spaghetti- Press Instalation .....	8
4.2	Compressed Air Connection.....	8
4.3	Power Supply .....	8
5	Instructions for Use .....	9
5.1	Normal Operation .....	9
5.2	Setting the speed.....	10
6	Maintenance Guidelines .....	10
6.1	Cleaning .....	10
6.2	Routine Maintenance .....	10
6.3	Troubleshooting and Debugging .....	11
6.4	Wear and Spare Parts .....	12
7	Fittings.....	13
7.1	Accesories (optional).....	13
8	Declaration of incorporation of partly completed machinery according to Machinery Directive 2006/42/EG Annex II 1B .....	14

## **GEPETTO ICE CREAM PRESS Model 180P**

### **1 Preface**

#### **1.1 Introduction**

We thank you for your confidence and congratulate you on the purchase of your new Ice Cream Spaghetti-Press 180P.

In order to achieve the maximum hygiene during its use, we have made special efforts to ensure that all parts that come into contact with the food products, are easy to disassemble and to clean.



The design of the Ice Cream Press 180P ensures the maximum hygiene with ease. It therefore achieves 100% the HACCP hygiene guidelines.

Please read this manual with all the information and instructions carefully and keep it for future references. We are sure that if you follow all the instructions contended in this manual, you will have much enjoyment and success with your new Ice Cream Spaghetti-Press 180P.

## 2 Safety Instructions

### 2.1 Symbols and Notes

Please observe the meaning of the following symbol and note explanations. These are classified according to ISO 3864-2.

 <b>CAUTION</b>	
	<b>Indicates a potentially dangerous situation. Failure to follow the instructions will result in property damage and minor or moderate personal injury.</b>

 <b>WARNING</b>	
	<b>Indicates a possible dangerous situation. Failure to follow the instructions will result in death or serious bodily injury (disability).</b>

<b>ADVICE</b>	
	<b>Indicates general instructions, useful user tips and working recommendations, which have no influence on the safety and health of the operator.</b>

## 2.2 Basic Security Instructions



These operating instructions serve as a basis for the safe use and operation of the ice cream press. These operating instructions, in particular the safety instructions, must be observed by all persons working on or with the ice cream press. In addition, the applicable rules and regulations for accident prevention at the place of use must be observed. The operating instructions must always be kept at the place of use of the ice cream press.

**The company GEPETTO-EIS is not liable for accidents that occur during the operation, cleaning and maintenance of the machine, if the safety instructions in this manual are not followed!**

## 2.3 Intended Use

The ice cream press is intended for pressing ice cream. The ice cream must not contain large pieces of fruit, nut, chocolate or other hard pieces to prevent damage of the press stamp.

For optimal operation, the ice cream should have a temperature of -14 to -17 ° C /  
-57,2 to -62,6 F.

 <b>CAUTION</b>	
	<b>Do not misuse the ice cream press for other purposes! Any misuse can lead to device damage!</b>

### 3 Device Description

#### 3.1 General Terms

The ice press is a device with which frozen ice cream can be pressed through a form disposer. The ice cream can be processed with different shapes of form disposers, i.e. spaghetti ice cream, lasagna ice cream and other forms.

The ice cream press consists of the following elements:

- Base plate with suction feet
- Head part with pneumatic pressure unit
- Drip tray (upper and lower part)
- Control tube
- Form disposer (different shapes are available, see 7.1 Accesories)

#### 3.2 Technical Specifications \*

- Dimensions (L x W x H): 255 x 150 x 590 mm / 10 x 5,91 x 23,23 inches
- Material: High quality stainless steel
- Operating mode: pneumatic
- Pressure performance up to 280 kg/cm<sup>2</sup> at 10 bar pressure
- Weight: 11 kg /24,25 lbs

\*Subject to change

## 4 Assembly Instructions

### 4.1 Spaghetti- Press Instalation

- Carefully remove the ice-press from its packaging.
- Do not use utility knives to open the packaging to avoid possible damage to the machine!
- Place the machine at the intended location. It can be set up freely or screwed firmly to the substructure. For this purpose there is an 0,31 inches / 8 mm threaded hole, in the bottom plate. Make sure that the machine is set up on a horizontal, firm and stable ground.

### 4.2 Compressed Air Connection

- To connect the ice press to an existing compressor, a hose of 6 mm diameter is required..
- Connect the other end of the hose assembly to the connector of the Spaghetti ice cream press. Insert hose as far as it will go. By briefly retracting the hose this is locked.
- **When installing the cable, please make sure that it is laid without kinks.**
- Switch on the compressor.
- Set the working pressure at the pressure reducer to 58 - 87 psi / 4 - 6 bar. Please also refer to the operating instructions of the manufacturer.

### 4.3 Power Supply

The ice cream press itself requires no electricity. It is exclusively operated with compressed air.



## 5 Instructions for Use

 <b>CAUTION</b>	
	<b>The ice cream press may only be operated by persons instructed in its handling.</b>

<b>ADVICE</b>	
	<b>Before putting your new ice press into operation, all parts in contact with food products must be thoroughly cleaned in order to eliminate any manufacturing residues!</b>

### 5.1 Normal Operation

- Fill the cooled form disposer with the appropriate amount of ice cream.
- Insert the form disposer from below into the guide tube.
- Lock the former by turning it counterclockwise.
- Turn further until it stops. In this case, the roller valve is actuated whereby the press stamp moves into the former and presses the ice located therein through the mold.
- Wait until the press stamp reaches the bottom of the form disposer and the entire ice cream has been pressed out.
- By turning the form disposer clockwise until it stops, the press stamp automatically returns to its original position and the form disposer is unlocked.
- Remove the form disposer downwards.  
It is recommended to keep the form disposer refrigerated when not in use.



## 5.2 Setting the speed

Under the top cover of the ice press a valve with choke is installed, this serves to regulate the speed of the pressure piston. **The power of the ice press always remains the same!**

By screwing in the adjusting screw on the choke valve, the working speed is reduced by unscrewing the adjusting screw the speed is increased.

## 6 Maintenance Guidelines

### 6.1 Cleaning

 <b>CAUTION</b>		
	<b>Before any maintenance and cleaning work, the machine must be set without pressure to avoid any injury!</b>	

- Put the compressor out of operation.
- Depressurize the ice cream press to avoid injury. To do this, move the ball valve in the compressed air connection line of the ice cream press or disconnect the compressed air connection line at the connector from the compressed air supply.
- Check if the ice cream press is depressurized.
- Loose the release screw on the front and unscrew approx. 0,20 inches /5 mm.
- Turn the guide tube clockwise as far as it will go and then pull it downwards.
- Unscrew the polyamide press stamp from the piston rod.  
**ATTENTION: The press stamp is screwed with left hand thread!**
- The form disposer can be cleaned occasionally when changing types of ice cream.
- Clean the removed parts (all parts are dishwasher safe).
- Reassemble in reverse order.

### 6.2 Routine Maintenance

- Lightly grease the seal of the press stamp for smooth running and long life after cleaning.
- Regularly check the oil level of the compressor on the sight glass.
- Regularly check the oil level of the compressor at least once a month to prevent corrosion in the compressor and to prevent contamination of the compressed air lines and the pressure cylinder (see also operating instructions of the compressor manufacturer)!
- The condensed water must be disposed properly.

### 6.3 Troubleshooting and Debugging

<b>Trouble</b>	<b>Possible Cause</b>	<b>Solution</b>
Ice cream press does not squeeze the ice cream	No compressed air, compressor off	Turn on the compressor
Ice cream press does not squeeze the ice cream	No compressed air, compressor not connected	Connect the compressor, check the lines for possible leaks
Ice cream press does not squeeze the ice cream	No compressed air although the compressor is connected	Check lines for possible leaks
Ice cream press squeezes too slow	Compressed air flows too slow	Increase the speed at the throttle valve
Ice cream press squeezes too fast	Compressed air flows too fast	Reduce the speed at the throttle valve
Ice cream press squeezes too weak	Air pressure too low	Increase the working pressure at the compressor

## 6.4 Wear and Spare Parts

Pos.	Art.-Nr.	Article Description
1	91075	Pneumatic cylinder, special version
2	91406	5/2-way pneum. Valve
3	91076	Exhaust air throttle
4	91418	Elbow joint
5	91401-1	Straight push-in fitting
6	91089	Silencer
7	91504	Suction cup Y 52 mm, colourless
9	91513	Guide tube with three finger system for 180P
10	91585	Press stamp PA 6 compl. w/ O-Ring
11	91524	O-Ring, red
12	91510	Counter discs for press stamps
13	91523	Locknut
14	91412	Straight connector, Type 2L03003 D 6 mm
16	91532	Drip tray, leak drawer, complete
17	91503	Hose 6 x 4 mm, black
18	91525	Coupling socket DN 5 für 6 x 4 mm hose
19	91526	Coupler plug DN 5 for 6 x 4 mm hose
21	50023	Coupler plug DN 7,2 for 6 x 4 mm hose
22	91425	Top cover ( stainless steel ) for 180P
23	91597	Back panel for 180P
24	91537	Locking screw

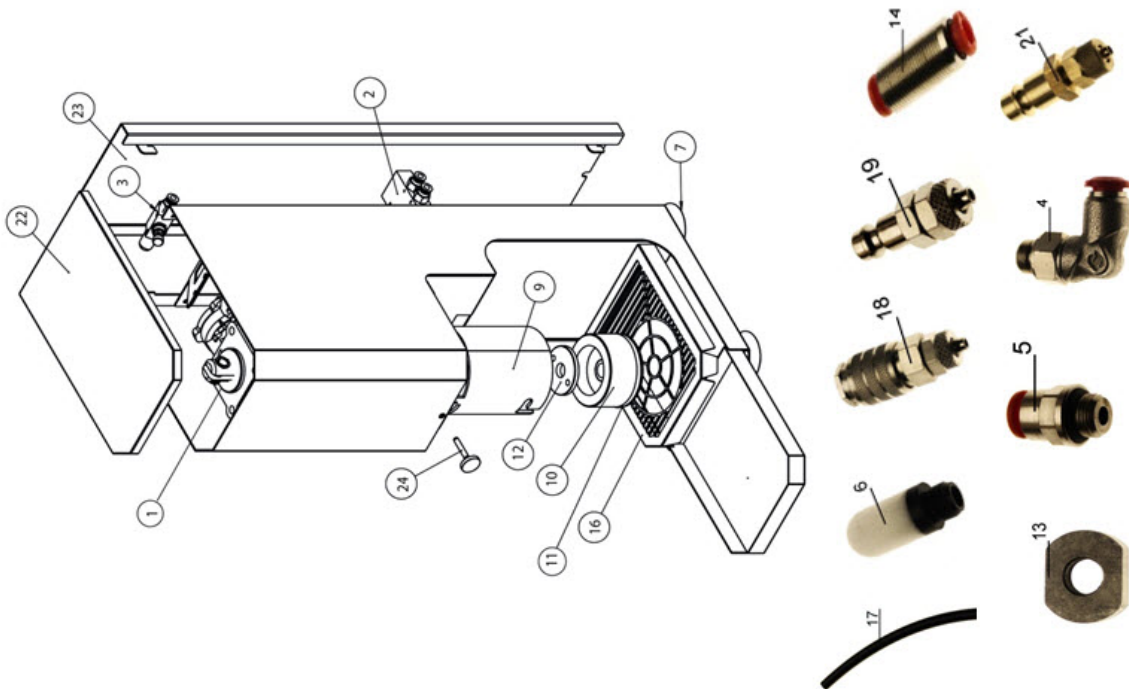

## 7 Fittings

### 7.1 Accesories (optional)

- Form disposer Spaghetti (Art. 91101)
- Form disposer Lasagna (Art.91103)
- Form disposer Asparagus (Art.91104)
- Form disposer Fetuccine (Art.91105)
- Form disposer Soft Serve ice cream (Art.91106)
- Form disposer French Fries (Art.91107)

Have fun with your new Ice Cream Spaghetti-Press 180P!

Your GEPETTO-Eis-Team



GEPETTO EIS

Visbeker Str.51

27793 Wildeshausen

EG-Identnr.: DE235961538

Tel.: +49 (0) 4431 92226

Fax: +49 (0) 4431 738398

[www.geppetto-eis.de](http://www.geppetto-eis.de)

<http://shop.geppetto-eis.de>

[info@geppetto-eis.de](mailto:info@geppetto-eis.de)

## 8 Declaration of incorporation of partly completed machinery according to Machinery Directive 2006/42/EG Annex II 1B

The Manufacturer Geppetto-Eis, Visbeker Straße 51, 27793 Wildeshausen, Germany  
Tel. +49 (0) 4431 9455606, info@geppetto-eis.de

hereby declares that the product

Spaghetti-Ice Cream Press, Model 180P

Serial-Nr. ....

represents an incomplete machine in the sense of the Machinery Directive **2006/42/EG** and basic health and safety requirements according to **Annex I** of this directive.

The incomplete machine complies further

- The relevant EC directives and regulations:
  - o Machinery Directive 2006/42/EG (in pieces)
  - o Regulation EG 1935/2004 about objects and materials in contact with comestibles
- The harmonized standards applied:
  - o DIN EN ISO 12100 - Security of machines
  - o DIN EN ISO 14159 - Hygiene requirements for the design of machines

The product is intended exclusively for installation in a machine or partly completed machine and therefore does not yet meet all the requirements of the Machinery Directive.

Product start-up is prohibited until it has been determined that the machine incorporating the above product meets all the essential requirements of the Machinery Directive.

The specific technical documentation in accordance with Annex VII, Part B has been prepared. The authorized representative for the compilation of the technical documentation undertakes to forward the documents to the national authorities upon a reasoned request. The transmission takes place by post in paper form or on electronic data carrier.

Authorized representative for the compilation of the relevant technical documentation is:

Jörn Johannsen, Techn. Employee, Geppetto-Eis

Visbeker Str. 51

27793 Wildeshausen

Germany

Wildeshausen, 30.06.2017



Visbeker Str. 51 - 27793 Wildeshausen  
Tel. 04431-945560-6 - Fax: 04431-738398  
e-Mail: info@geppetto-eis.de

Karina-Claudia Ienco  
Geschäftsführung  
Geppetto-Eis

Other products from the house Geppetto-Eis:



### Turbomixer Piccolo

The Turbo Mixer Piccolo is the ideal helper for any ice cream lab or kitchen. It impresses with its compact design, easy operation and reliability in normal working conditions. Adjustable speed, powerful engine and various beaters bring you the desired result. The device is also available with digital control for time and speed - the ideal solution to achieve the best degree of homogeneity of the ice cream mass. We will be glad to help you to find the right device for your needs. In addition, we offer the full spare parts for our devices as well as repair service.

### Ice Cream Scoop Rinser & Dryer

Our house award-winning developed Scoop Rinser and Dryer offers you the maximum of hygiene and protection against bacteria with a child's play handling!



In addition, gives you the advantage that with the scoop dryer no more drops of water will end up in the ice cream! Different designs and sizes are available.



### Ice Cream Basins

For the proper storage we recommend our stainless steel ice cream basins!

Small, medium or large; stainless steel ice cream basins in the usual sizes and shapes are always in stock. If you need special formats, feel free to contact us!



**Geppetto Eis**

Visbeker Str.51

27793 Wildeshausen

Tel.: +49 (0) 4431 92226

Fax: +49 (0) 4431 738398

E-Mail: [info@geppetto-eis.de](mailto:info@geppetto-eis.de)

<http://shop.geppetto-eis.de>

Homepage: [www.geppetto-eis.de](http://www.geppetto-eis.de)

